

CoolMax SRX Charge Controller

Installation and Operation User Manual



Models

SRX 60 180

SRX 45 290

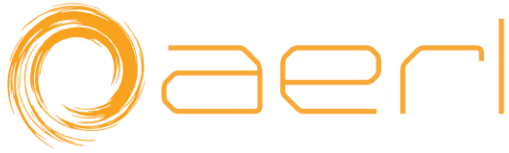

About Australian Energy Research Laboratories

Australian Energy Research Laboratories (AERL) was founded by Stuart Watkinson (BE Elec. Eng., Grad. M.I.E.A) in 1985 to commercialize the “Power Optimizer”, a revolutionary solution to a complex problem, developed while studying at the University of Queensland in Brisbane, Australia.

Unlike many inventors, Stuart possessed not only a great idea, but also the entrepreneurial skill to turn it in to a commercially viable product. The “Power Optimizer” would eventually come to be known as the AERL MAXIMIZER™, the world’s first truly Universal Maximum Power Point Tracker (MPPT).

Today, AERL manufactures a range of highly reliable and efficient specialised power electronic controllers for use in Solar, Micro Hydro, Micro Wind and Cathodic Protection applications.

Contact Information

Address: Unit 15, 1015 Nudgee Rd,
Banyo, QLD, 4078, Australia

Phone: [+61 07 3129 0330](tel:+610731290330)

Email: sales@aerl.com.au

Website: <https://www.aerl.com.au>

Disclaimer

UNLESS SPECIFICALLY AGREED TO IN WRITING, AUSTRALIAN ENERGY RESEARCH LABORATORIES:

(a) MAKES NO WARRANTY AS TO THE ACCURACY, SUFFICIENCY OR SUITABILITY OF ANY TECHNICAL OR OTHER INFORMATION PROVIDED IN ITS MANUALS OR OTHER DOCUMENTATION.

(b) ASSUMES NO RESPONSIBILITY OR LIABILITY FOR LOSS OR DAMAGE, WHETHER DIRECT, INDIRECT, CONSEQUENTIAL OR INCIDENTAL, WHICH MIGHT ARISE OUT OF THE USE OF SUCH INFORMATION.

THE USE OF ANY SUCH INFORMATION WILL BE ENTIRELY AT THE USER’S RISK.

Notice of Copyright

CoolMax SRX Charge Controller Owner’s Manual © July 2018 by Australian Energy Research Laboratories Pty. Ltd. All Rights Reserved.

Trademark

AERL and the AERL logo are trademarks owned and used by Australian Energy Research Laboratories Pty. Ltd.

These trademarks may be registered in Australia and other countries.

Effective Date

July 2018 (07/2018)



Table of Contents

Warranty Conditions	5
Specifications	6
Introduction	7
Features	7
Firmware	7
Installation	8
Standards & Requirements	8
Grounding	8
Ground Fault Detection & Interruption	9
Ground Fault Detection & Interruption Solutions	10
GDFI Optional Extra	10
Mounting the Controller	11
Wiring Information	12
Wire and Disconnect Sizing	12
CoolMax 60 180	12
CoolMax 45 290	12
Wiring Compartment	13
Wiring Polarity	14
Operation	15
Powering Up	15
Power Saving Mode	15
Programming the Device	16
Battery Charge Profile	17
Setting the Battery Charge Profile	18
Enabling the Output	21
Setting the Time/Date	22
Battery Temperature Compensation	23
Connecting the Temperature Sensor	23
Temperature Sensor Location	23
Troubleshooting	24

Important Safety Information

This Installation Manual contains important safety information and installation instructions for the AERL COOLMAX SRX MPPT Solar Charge Controller.

The following symbols are used throughout this user manual to indicate ideal installation methods, potential dangerous conditions and important operational information.



IMPORTANT

Indicates information that must be followed to ensure proper operation of the COOLMAX SRX.



CAUTION

Indicates a critical procedure for the safe installation of the COOLMAX SRX. Use extreme caution when performing this task.

About this Manual



IMPORTANT

- This User Manual provides detailed installation and usage instructions for the COOLMAX SRX unit. It is recommended that all of the Instructions and Cautions in this User Manual be read before beginning installation.
- Only qualified electricians and technicians should install the COOLMAX SRX. This manual is intended for all installation technicians and the system owner.
- Do not disassemble or attempt to repair the COOLMAX SRX unless you are a qualified technician and have authority in writing from AERL to do so.
- AERL will not be held responsible in any way for the mishandling of this product or for installation of the product in a manner that does not follow the instructions in this manual or as advised by an AERL technician.



Warranty Conditions

¹ Warranty Duration from the Date of Purchase

Warranty Requirements	Total Warranty Duration
1. You are the original purchaser of the CoolMax SRX.	3 Years
2. You are the original purchaser and registered your warranty online within 60 days of installation.	5 Years

Our goods come with guarantees that cannot be excluded under the Australian Consumer Law. You are entitled to a replacement or refund for a major failure and compensation for any other reasonably foreseeable loss or damage. You are also entitled to have the goods repaired or replaced if the goods fail to be of acceptable quality and the failure does not amount to a major failure.

AERL will bear the cost of parts and labour to repair any manufacturing faults found within the terms and period of this warranty. For claims under warranty, the faulty product(s) must be returned to AERL’s facility at Unit 15, 1015 Nudgee Road, Brisbane, Australia, after contacting AERL and receiving the appropriate RMA documentation from AERL.

No allowance is made for labour or travelling time required to disconnect or reinstall faulty parts. AERL will pay the cost of freight to return the repaired charge controller to the customer within Australia or New Zealand only. The method of freight will be determined by AERL.

All installation and user conditions as set down in the instruction manual must be strictly adhered to as failure to do so may void your warranty. Any faults or like faults caused by lightning, water or moisture ingress, vermin infestation, improper voltage, faulty installation, use of the product in a manner for which it is not intended, alterations which affect the reliability or performance of the unit but are not attributable to faulty manufacture, failure to act on service warning from the AERL charge controller, or damage caused by other system components will not be covered under warranty.

The degradation or failure of consumable components (cooling fans and power capacitors reaching end of life) is not covered under this warranty. In the event of the product being out of service, AERL shall bear no responsibility for any consequential loss or expense. AERL will not be held responsible for any misleading or incorrect information conveyed by anyone not directly employed by AERL.

Visit www.aerl.com.au/activate-warranty and fill out the associated form to activate your full AERL warranty.

Note 1: Warranty conditions outlined in this document apply to charge controllers registered online on or after the 13th of June 2018. Warranty conditions remain current until the next revision of this document is published. Proof of purchase is required when making a warranty claim.

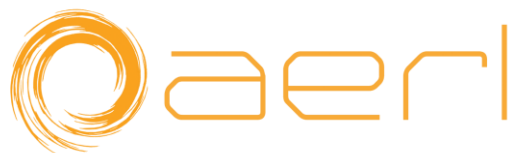

Specifications

General Specifications		
Parameter	Typical	
Weight	7 kg	
Dimensions (L x W x H)	480 x 226 x 111 mm	
Enclosure Type	Indoor Type1 / IP20	
Input / Output Power Connectors	Screw Terminals (35mm ² , AWG2)	
Characteristics	SRX 60 180	SRX 45 290
Nominal Battery Voltage - Selectable	32 to 84V	48 to 132V
Maximum Charge Current	60A	45A
Maximum Recommended PV Array	5000W @ 84Vout(nom) 3800W @ 60Vout(nom) 3000W @ 48Vout (nom) 2000W @ 32Vout(nom)	5200W @ 132Vout(nom) 5000W @ 120Vout(nom) 4500W @ 96Vout(nom) 2300W @ 48Vout(nom)
Maximum PV Voltage Open Circuit	180V	290V
Maximum Conversion Efficiency	99%	99%
Battery Temperature Compensation	Yes	Yes
Ambient Operating Temperature Range (Full Rated Output up to 80% Ambient °C)	-20 to 50 °C	-20 to 50 °C
Remote Temperature Sensor Option	Yes	Yes
Storage Temperature	-30 to 70 °C	-30 to 70 °C
Self-Consumption	100mA @ 20V	75mA @ 40V
Communications Protocol Options	Modbus RTU & CAN bus	Modbus RTU & CAN bus
Communication Ports	RS485 & USB	RS485 & USB
Required Cabinet Air Exchange Rate (Intake @ 40°C)	40m ³ /hour	40m ³ /hour
Heatsink Temperature @ Full Power	35°C Rise	45°C Rise
Sealed Inductors & Internal Conformal Coating	Yes	Yes
Conforms to	IEC62109-1 RoHS CE & CTick	IEC62109-1 RoHS CE & CTick
Languages Available	English	English



Introduction

Thanks for by purchasing an Australian made CoolMax Series Charge Controller.

AERL charge controllers offer an efficient and reliable charging process that not only maintains battery efficiency and life but maximizes power generation by utilizing the full potential of your PV array.

Features

CoolMax Charge Controllers utilize an advanced form of Maximum Power Point Tracking (MPPT) technology to extract the maximum power available from your PV array, efficiently charging your batteries and maximizing power generation.

AERL's Maximum Power Point Tracking (MPPT) algorithm has been proven to be highly robust, resistant to local extremes, and results in power losses of less than 0.5% over the whole operating temperature range of a PV Array.

- Superior Peak Power Efficiency > 99%
- Ultra-low heat Thermal Design
- Designed for Long Term Reliability
- Higher Input Voltages - Lower Install Costs
- Built-In Overload and Thermal Protection
- Common Positive Wiring Configuration
- Master/ Slave Configuration Options
- Interactive Touch Screen Configuration
- Smart Multi-Stage Battery Charging

Firmware

This installation and operating manual covers CoolMax SRX Firmware Revisions v2.1.x.

Installation



IMPORTANT

The COOLMAX SRX must be installed in a clean, dry location away from direct sunlight.

Optimal cooling is achieved when the COOLMAX SRX is mounted vertically. A minimum of 20cm should be kept clear above the COOLMAX SRX to allow for air flow.



CAUTION – Equipment Damage

AERL COOLMAX Charge Controllers are not designed to be used in parallel with other Third-Party Charge Controllers and this will void your warranty.

Standards & Requirements

All installations must comply with national and local electrical standards and codes of practice. AERL recommends professional installation.

Grounding

AERL Charge Controllers are designed to be installed in floating systems but contain provisions for negative or positive functional earthing if required.

CoolMax controllers are not intended to be wired into a positive-ground configuration from factory. However, certain telecom applications may require this configuration. If it a positive ground configuration is required, please contact AERL at support@aerl.com.au or on +61 [07 3129 0330](tel:0731290330) prior to purchase.



IMPORTANT

The CoolMax Ground (located inside the enclosure) is marked with the following symbol:



CAUTION – Hazard

If damaged or malfunctioning, the AERL controller should only be disassembled and repaired by a qualified service centre. Please contact the local renewable energy dealer/installer for assistance.

Incorrect reassembly risks malfunction, electric shock or fire.

Ground Fault Detection & Interruption



IMPORTANT

Effective *11th July 2015*, all solar PV installations in Australia and New Zealand require an external earth fault alarm to be installed on equipment classified as Power Conversion Equipment (PCE).

As Solar Charge Controllers (CoolMax SRX 60 180 & 45 290) fall under this classification, they will require an earth fault alarm to be installed.

(Refer to AS/NZS5033:2014 clause 3.4.3).

- a. In systems where the PV array is operating at LV, an earth fault alarm system shall be installed which, on an earth fault causes an action to be initiated to correct the earth fault.
- b. The alarm system is to continue repeating its operation at least at hourly intervals until the earth fault is corrected.
- c. The alarm system may be an audible signal or visual indicator placed in an area operational staff or system owners will be aware or another form of fault communication, for example fax, email, SMS or similar, shall be applied to inform to the system operator.
- d. A set of operational instructions shall be provided to the system owner that includes the actions to take when the alarm operates.

Operating Voltage < 120VDC

Equipment operated at ELV is not subject to AS/NZS5033:2014 clause 3.4.3 and exempt from requiring a Ground Fault Circuit or Remote Ground Fault Indicator.

Operating Voltage ≥ 120VDC

Installations where the operating voltage is greater than 120VDC an external Ground Fault Protection kit and Remote Ground Fault Alarm are required. Recommended solutions can be found on page 10 of this user manual.

Multiple Unit Installations

When two or more Solar Charge Controllers are installed on the same battery bank, disable all but one Ground Protection Circuit and only a single Ground Fault Indicator is required.



Ground Fault Detection & Interruption Solutions

Recommended solutions can be found illustrated below.

	Negative Grounded	Positive Grounded	Floating
Ground Fault Protection Circuit	<p>AERL Optional GFDI Device</p> <p>Part No. AER-GFDI-N</p>	<p>AERL Optional GFDI Device</p> <p>Part No. AER-GFDI-P</p>	<p>Install a Bender Isometer IR425 between PV –ve, PV +ve and Ground.</p> <p>Part No. B71036402</p>
Remote Ground Fault Indication (Options)	<p>System Information/Alarms Screen</p> <p>CoolMax Modbus RTU & CAN bus Comms for connection to external devices.</p>	<p>System Information/Alarms Screen</p> <p>CoolMax Modbus RTU & CAN bus Comms for connection to external devices.</p>	<p>Bender IR 425 Auxiliary relay for connection to external devices.</p>

Refer to the installation and operating manuals for the respective equipment for detailed installation and programming instructions.

GDFI Optional Extra

TBA.

Mounting the Controller

The COOLMAX SRX should be fixed to a vertical surface using the M5 screws provided. The SRX has 8 wall mounting holes in the chassis flanges as demonstrated below in **Figure 2a**.

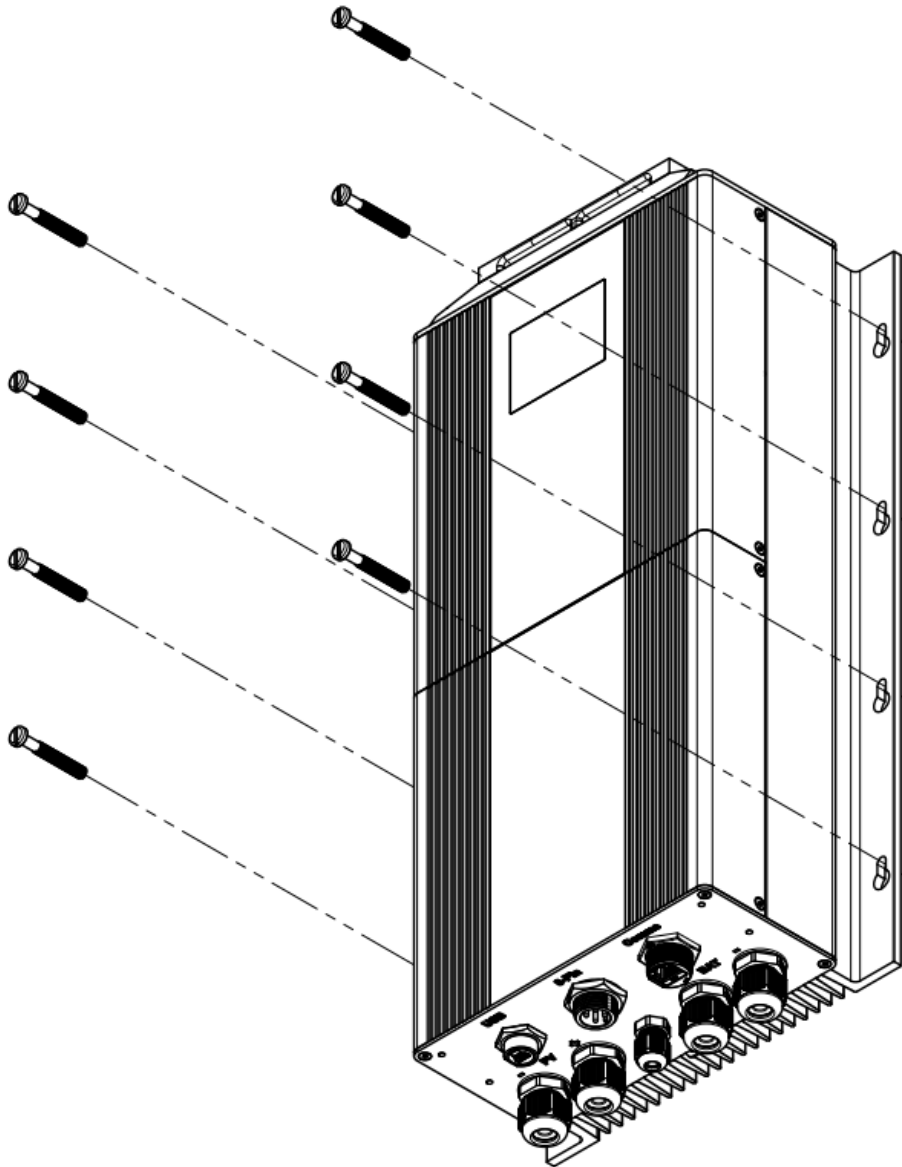

Figure 2a: SRX Mounting Hole Locations

Wiring Information

This section will provide information and instructions for installing PV array wiring into the CoolMax Controller.

Wire and Disconnect Sizing



IMPORTANT

- Wire sizes must comply with local and national standards. Input conductors and circuit breakers must be rated at 1.56 times the short-circuit current of the PV array.
- Copper wiring must be rated at 75°C or higher.
- Use up to 2 AWG (33.6mm²) to reduce losses and ensure maximum energy harvest (Smaller cable sizes may reduce performance and damage the CoolMax).

CoolMax 60 180

- The output current limit of the CoolMax 60 180 is 60 amps.
- Use a minimum of #6 AWG (13.3 mm²) wire for the output between the CoolMax and the battery bus bar or termination.
- Use an appropriately sized insulated crimp ferrule when terminating both the input and output connections.
- Torque all CoolMax wire and ground terminals to 4 Nm (35 in-lb).

CoolMax 45 290

- The output current limit of the CoolMax 45 290 is 45 amps.
- Use a minimum of #8 AWG (8.4 mm²) wire for the output between the CoolMax and the battery bus bar or termination.
- Use an appropriately sized insulated crimp ferrule when terminating both the input and output connections.
- Torque all CoolMax wire and ground terminals to 4 Nm (35 in-lb).

Please refer to the relevant IEC or AS/NZS electrical code for recommendations on PV array cable sizing, length and ampacity.

Wiring Compartment



CAUTION – Hazard

All CoolMax SRX wiring must enter the unit through the correctly labelled cable glands in the base plate.

Under absolutely **no circumstances** should holes be drilled anywhere into the unit to make other cable entry points. Doing so can cause metal swarf or fillings to enter the internal electronics and damage the unit once powered up.

Drilling of any holes into the unit will void all product warranty.

To install cabling, the access panel of the COOLMAX SRX must be removed. This is done by removing the two M4 countersunk Philips screws on the bottom of the enclosure and the two M3 countersunk Philips screws on either side of the access panel. **Refer to Figure 2b below for access screw locations.**

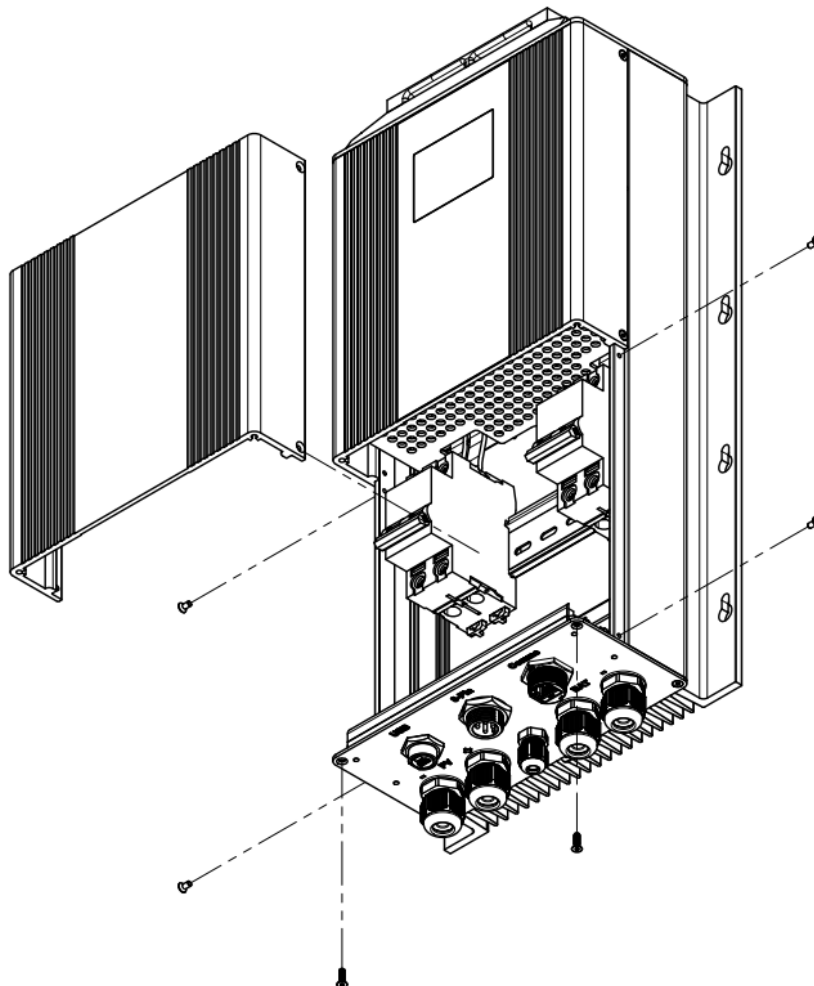

Figure 2b: SRX Access Panel Screw Locations

Wiring Polarity



CAUTION – Equipment Damage

Reversing the polarity of either the input or output will damage the CoolMax SRX and void product warranty.

Confirm polarity with a DVM prior to closing the I/O breakers.

With the access cover removed, the internal I/O breakers will be visible. If the unit has the optional GFDI fitted, it will be located in-between said breakers. **Refer to Figure 3 below for wiring polarity.**

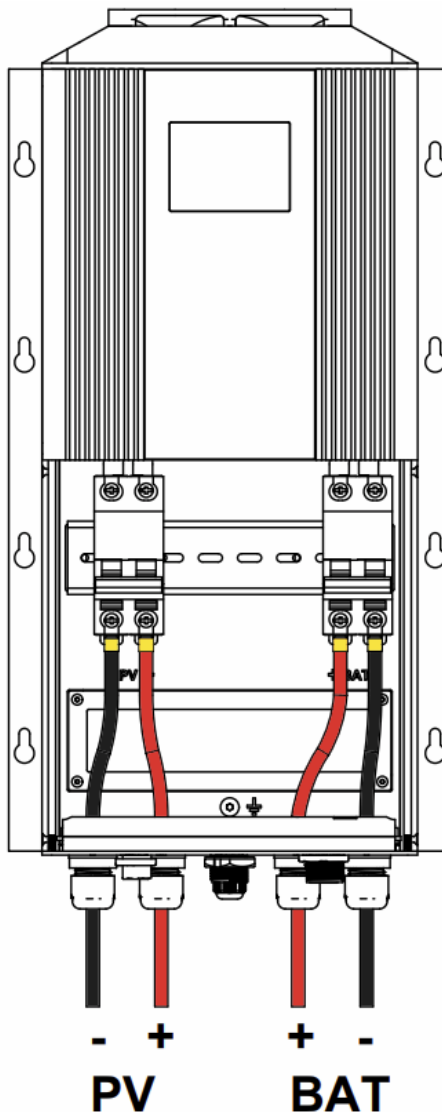

Figure 3: SRX Access Cover Removed

Operation

Powering Up

The CoolMax SRX will power up when a PV or Battery voltage is applied.

Note: Minimum voltage required is 30 Vdc.

When the COOLMAX SRX is first powered the on, the Real Time Screen (**Figure 4a**) is the first screen to appear. This Real Time Screen displays live telemetry information relevant to the COOLMAX SRX and is the starting point from which the COOLMAX SRX configuration can be performed.

30/05/2018		MV	SRX	V2.3	Bulk	13:10
PV	165.31V	Battery	45.09V			
Amps In	12.56A	Amps Out	43.2A			
Charge:	(0289.1)	35.94 Ah				
PV Voc	178.6 V					
PV Power:	2075.1 W					
Temperature (I) :	+29.15 C					
Menu	ON/OFF			Alarms		

Figure 4a: CoolMax Real Time Telemetry Screen

Power Saving Mode

When the CoolMax SRX touch screen has been idle for 40 seconds, the screen will switch to power saving mode. When the unit is in power saving mode, the screen will be dimmed. To revert to full brightness, simply tap the screen.

Programming the Device

The CoolMax SRX is programmed and controlled via the touch screen display located on the front of the device. ***The location of the touch screen can be seen in figure 4b below.***

The screen allows the user to view real time telemetry, edit the charge profile and view alarms, alerts and system information.

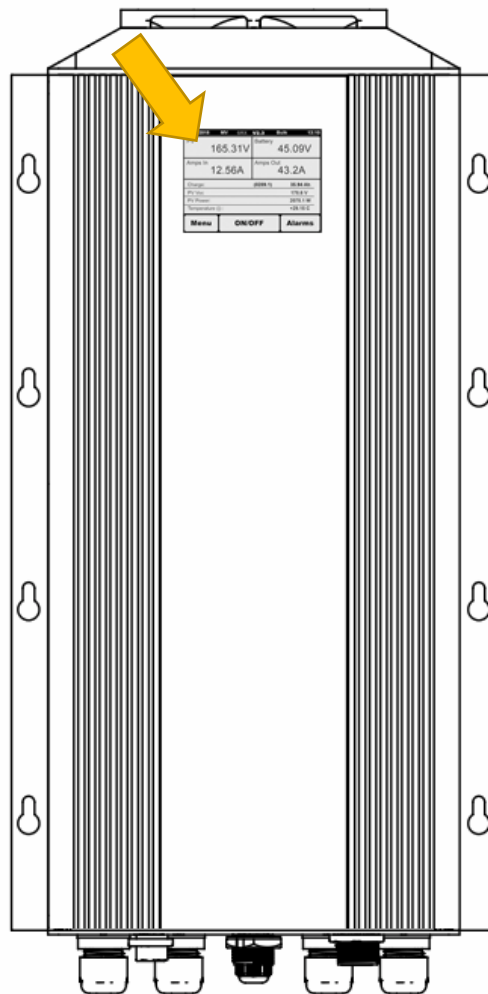

Figure 4b: CoolMax Touch Screen Location

Battery Charge Profile



IMPORTANT

The CoolMax SRX default charge profiles are intended for Lead Acid battery solutions.

AERL does support some other battery chemistries such as Lithium options that **do not** require external BMS communications. I.e. GenZ, Simpliphi, etc.

AERL is working with various battery manufacturers to expand out of the box comms support for Lithium batteries that require communication with the Charge Controller.

Please contact AERL support to confirm compatibility prior to installation. Additional battery support will be rolled out via firmware updates which can be downloaded from AERL's website.

The CoolMax SRX charge output will not automatically activate for safety reasons. Prior to activating the charge output, the charge profile must be configured for the relevant battery solution being utilized.

The SRX operates using an advanced three-stage charging process and has pre-set charge voltage profiles for each supported nominal battery voltage. That said, AERL always recommends referring to the battery manufactures specifications regarding charge voltages for optimal battery life and performance.

These voltages can be adjusted in the charge profile settings. Refer to **page 18** for instructions.

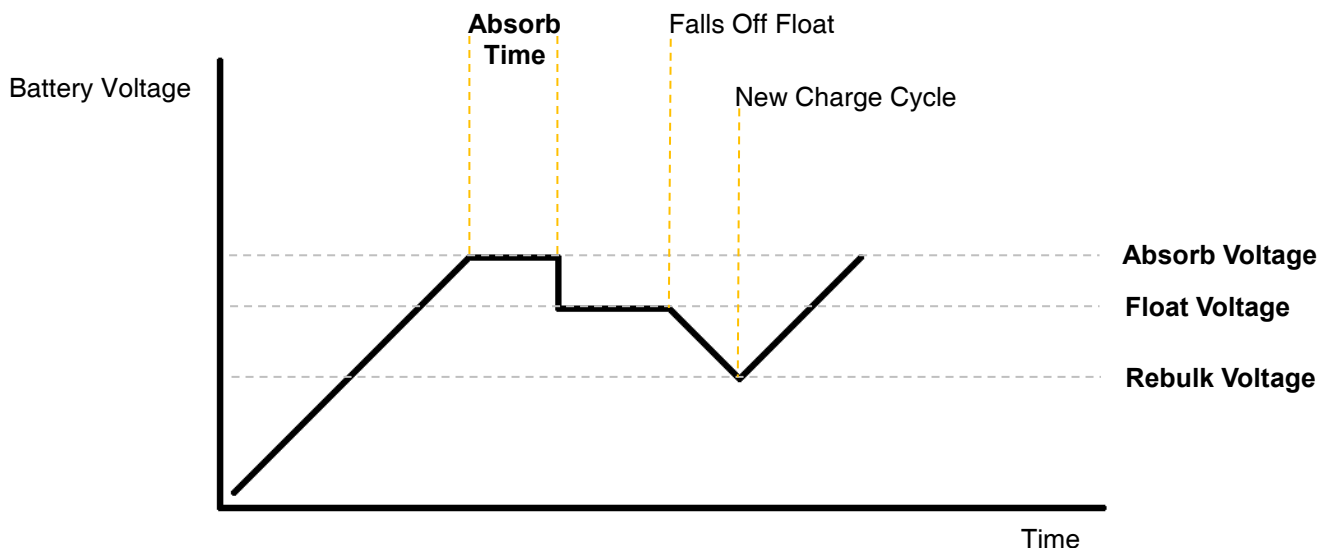

Figure 5: Battery Charge Profile Illustrated

Setting the Battery Charge Profile

Setting the battery charge profile can be done by following the steps below.

Step 1 – Tap the MENU button located in the left-hand corner of the live telemetry screen.

30/05/2018		MV	SRX	V2.3	Bulk	13:10
PV	165.31V	Battery	45.09V			
Amps In	12.56A	Amps Out	43.2A			
Charge:	(0289.1)	35.94 Ah				
PV Voc					178.6 V	
PV Power					2075.1 W	
Temp (I):					+29.15 C	
Menu		ON/OFF		Alarms		

Step 2 – Tap the SETTINGS button located at the top of the MAIN MENU.

Back	MAIN MENU
	Settings
	Information
	Alarms

Step 3 – Tap the SET POINTS button located at the top of the SETTINGS MENU.

Back	SETTINGS
	Set Points
	Date & Time
	Comms

Step 4 – You are now on the SET POINTS screen. The setting currently selected will be highlighted in orange. Tap **EDIT** to edit the selected option or **UP/DOWN** to move between settings.

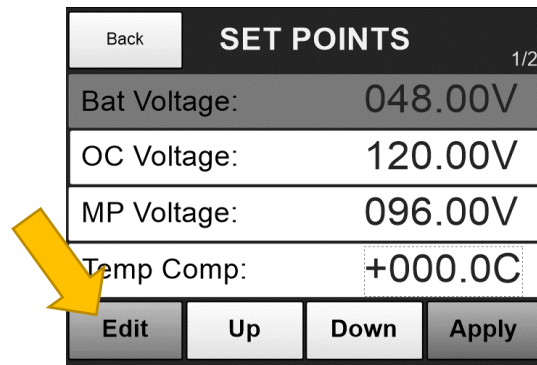

IMPORTANT

There are **two pages** (1/2, 2/2) of charge profile settings.

Selecting the Nominal Battery voltage and tapping “**Apply**” will automatically fill the second page with a default configuration for that selected voltage.



CAUTION – Equipment Damage

AERL recommends referring to the battery manufactures recommendations as to the appropriate charge profile. **The default profile may not be suitable for the battery system being utilized.**

Failure to do so may cause damage to or reduce the life of the battery system.

Step 5 – **Input** the security pin code to edit the chosen setting. (Default: 1111)

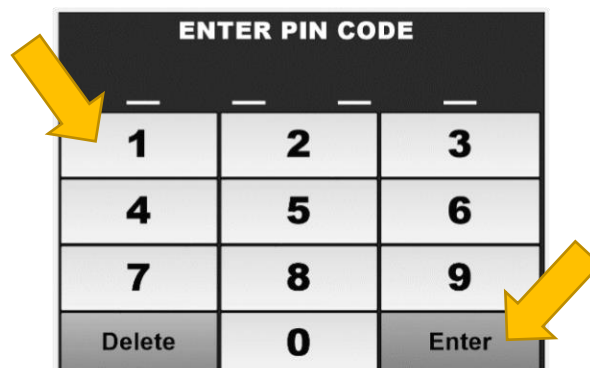

Step 6 – Adjust the setting using the **UP** and **DOWN** buttons until the desired voltage is specified and then tap **Apply**.

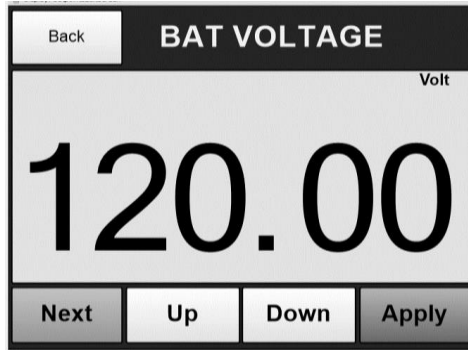

Step 7 – Finally, save your charge profile by tapping **Apply**. The CoolMax will save your settings and proceed to reset/reboot.

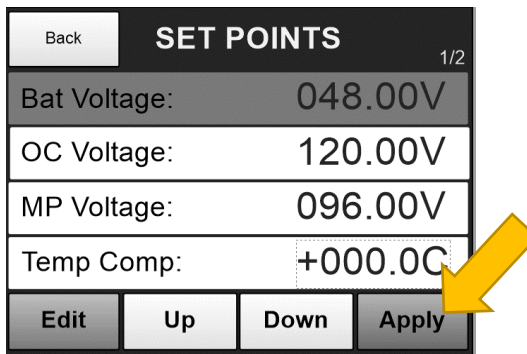

IMPORTANT

If any of the set point inputs are above the allowable system parameters, a warning message will be displayed and the CoolMax will not allow the charge profile to be saved.

Please refer to **page 17** for information on setting the correct charge profile settings.



IMPORTANT

If you do not tap “**Apply**” after you have finished entering the settings, the CoolMax SRX will not the load the new charge profile into memory and you will have to repeat the process.

Enabling the Output

To activate output battery charge, press the ON/OFF button located at the bottom of the CoolMax Real Time Telemetry screen (**Figure 4a**).

This will take you to the **OUTPUT CONTROL** screen which will allow you to enable the output (**Figure 6**).

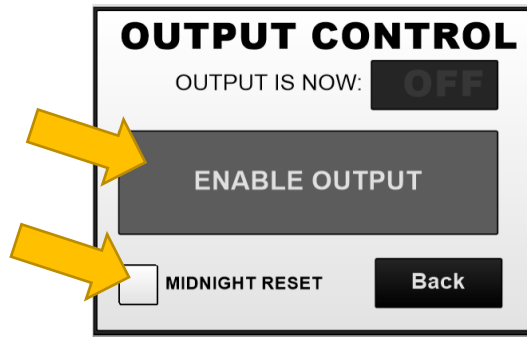

Figure 6: CoolMax Output Control (Output OFF)

Tick the **Midnight Reset** Checkbox and press the **ENABLE OUTPUT** button (Figure 6) to turn Battery Charge output ON.

The **OUTPUT CONTROL** screen will show the **OUTPUT IS NOW ON** (Figure 6A) after a few seconds.



Figure 6A: CoolMax Output Control (Output ON)



IMPORTANT

If no Battery output or PV input voltage is detected by the CoolMax SRX, the device will switch to auto output cycling and will attempt to activate the battery charge output every 30 seconds until the device is shutdown or the output activates.

Setting the Time/Date

From the Real Time Telemetry Screen (Figure 5), select the Menu button at the bottom left of the page to take you to the MAIN MENU screen page (Figure 7).

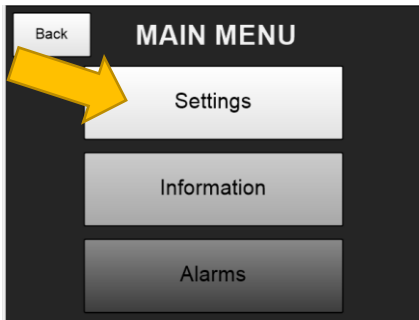

Figure 7: Main Menu Screen

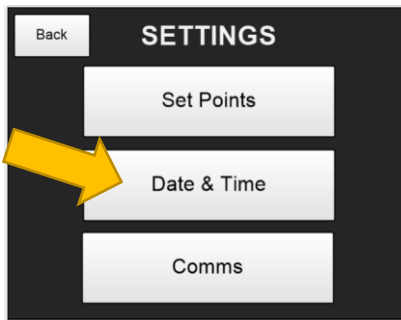

Figure 8: Settings Screen

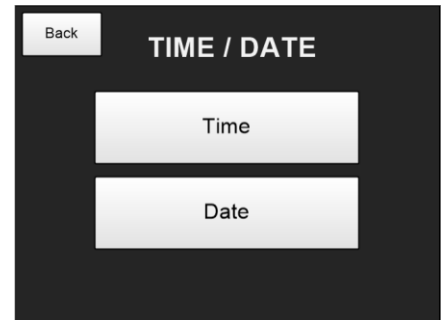

Figure 9: Time / Date Screen

Then press the **SETTINGS** button on the MAIN MENU screen page and this will take you to the SETTINGS Screen (Figure 8). On the SETTINGS Screen page (Figure 8) press the TIME / DATE button and this will take you to the TIME / DATE Screen page (Figure 9).

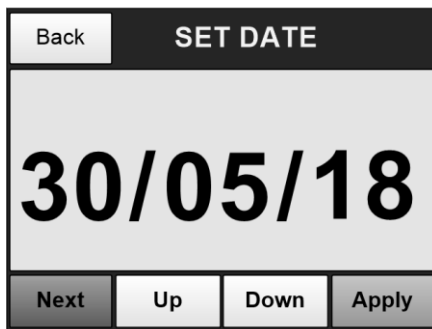

Figure 10A: Date Edit Screen



Figure 10B: Time Edit Screen

To set the Time, press the **TIME** button on the TIME/ DATE screen and this will take you to the SET TIME Screen (Figure 10B). When you reach the SET TIME screen (Figure 10B), use the “Next” button at the bottom left of the page to move between the various digits and the “Up” and “Down” buttons to edit the digits.

Once you have the correct Time setting, press the “Apply” button to lock in the new setting. This will also take you back to the TIME / DATE screen (Figure 9) from which you can now set the Date.

To set the Date, press the **DATE** button on the TIME/ DATE screen and this will take you to the SET DATE Screen (Figure 10A). When you reach the DATE EDIT screen (Figure 10A), use the “Next” button at the bottom left of the page to move between the various digits and the “Up” and “Down” buttons to edit the digits.

Once you have the correct Date setting, press the “Accept” button to lock in the new setting and take you back to the TIME / DATE screen.

Battery Temperature Compensation



IMPORTANT

To utilize the CoolMax SRX battery temperature compensation functionality, an AERL CoolMax SRX Remote Temperature Sensor will be required.

Part Number: SRX-RTS-3

Temperature compensation measures the temperature of the batteries and adjusts the float voltage set point to the ideal voltage for batteries at that temperature.

Using the temperature of the batteries, the COOLMAX SRX adjusts the float voltage by a user specified factor in millivolts per °C. The temperature compensation factor can be set using the COOLMAX SRX front panel LCD display.

Please refer to page 16 of this User Manual for instructions on how to edit this setting in the charge profile.

Connecting the Temperature Sensor



IMPORTANT

A temperature compensation value must be set in the charge profile before the CoolMax SRX will begin to utilize the remote temperature sensor.

To connect your remote temperature sensor to the CoolMax SRX, locate and remove the protective cap from the 8-Pin connector on the bottom of the CoolMax Charge Controller.

Insert the remote temperature sensor connector into the 8-Pin connection (Make sure the orientation is correct and do not force the connection).

Once the connector is inserted, lock it in place by turning the outer ring until the connector is secured.

Temperature Sensor Location

The CoolMax SRX remote temperature sensor should be located in close proximity to the battery cells for accurate results.



CAUTION – Equipment Damage

Do not place the RTS in a location where it may be exposed to water, moisture, direct sunlight or chemical material.



Troubleshooting

If the COOLMAX SRX detects a fault, an alarm will be triggered in the ALARMS tab on the Real Time Telemetry screen.

Please refer to the table below for fault codes.

Note: Fault Codes & the full CoolMax troubleshooting guide and documentation will be added shortly. In the meantime, please contact AERL at either support@aerl.com.au or on [07 3129 0330](tel:0731290330), we're happy to help assist with any queries you may have.



USER MANUAL

COOLMAX SRX – Wall Mount

Australian Energy Research Labs

AER07.004 – G3 Rev 1

10th July 2018

This page has been intentionally left blank.



USER MANUAL

COOLMAX SRX – Wall Mount

Australian Energy Research Labs

AER07.004 – G3 Rev 1

10th July 2018

This page has been intentionally left blank.



USER MANUAL

COOLMAX SRX – Wall Mount

Australian Energy Research Labs

AER07.004 – G3 Rev 1

10th July 2018

This page has been intentionally left blank.