

SmartShunt 500A / 1000A / 2000A

www.victronenergy.com

The SmartShunt is an all in one battery monitor, only without a display. Your phone acts as the display.

The SmartShunt connects via Bluetooth to the VictronConnect App on your phone (or tablet) and you can conveniently read out all monitored battery parameters, like state of charge, time to go, historical information and much more.

Alternatively, the SmartShunt can be connected and be read by a GX device. Connection to the SmartShunt is made via a VE.Direct cable.

The SmartShunt is a good alternative for a BMV battery monitor, especially for systems where battery monitoring is needed but less wiring and clutter is wanted.

The SmartShunt is equipped with Bluetooth, a VE.Direct port and a connection that can be used to monitor a second battery, for midpoint monitoring, or to connect a temperature sensor.

Differences compared to BMV712 Battery Monitor

- No programmable visual and audible alarm.
- No programmable relay.



SmartShunt 500A



SmartShunt 1000A



SmartShunt 2000A

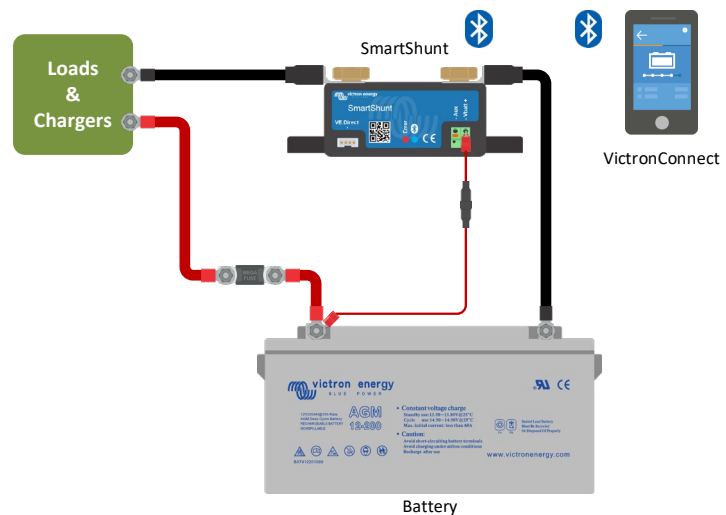

Basic SmartShunt wiring

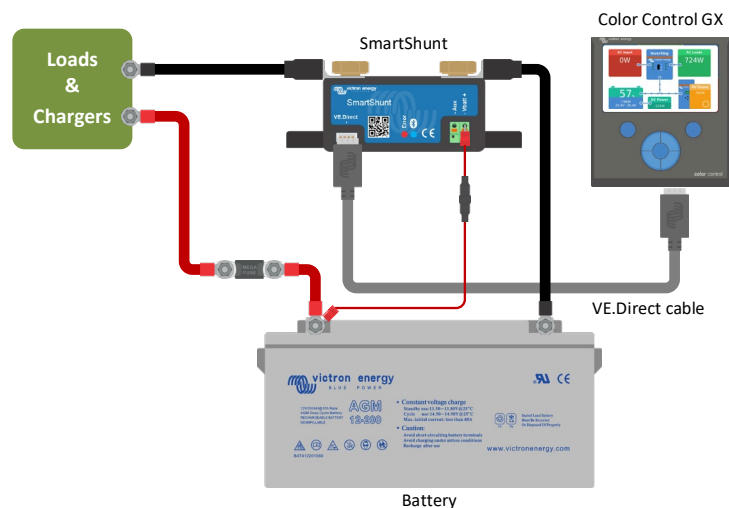

Connecting a SmartShunt to a GX device

SmartShunt	
Supply voltage range	500A / 1000A / 2000A
Current draw	6,5 - 70 VDC
Input voltage range, auxiliary battery	< 1mA
Battery capacity (Ah)	6,5 - 70 VDC
Operating temperature range	1 - 9999 Ah
Measures voltage of second battery, or temperature, or midpoint	-40 +50°C (-40 - 120°F)
Temperature measurement range	Yes
VE.Direct communication port	-20 +50°C
VE.Direct communication port	Yes
RESOLUTION & ACCURACY	
Current	± 0,1A
Voltage	± 0,01V
Amp hours	± 0,1 Ah
State of charge (0 - 100%)	± 0,1%
Time to go	± 1 min
Temperature (if optional temperature sensor connected)	± 1°C/°F (0 - 50°C or 30 - 120°F)
Accuracy of current measurement	± 0,4%
Offset	Less than 20 / 40 / 80 mA
Accuracy of voltage measurement	± 0,3%
INSTALLATION & DIMENSIONS	
Dimensions (h x w x d)	500A: 46 x 120 x 54 mm 1000A: 68 x 120 x 54 mm 2000A: 68 x 120 x 76 mm
Protection category	IP21
STANDARDS	
Safety	EN 60335-1
Emission / Immunity	EN-IEC 61000-6-1 EN-IEC 61000-6-2 EN-IEC 61000-6-3
Automotive	EN 50498
Cables (included)	Two cables with 1A fuse, for '+' connection and starter battery or midpoint connection
Temperature sensor	Optional (ASS000100000)

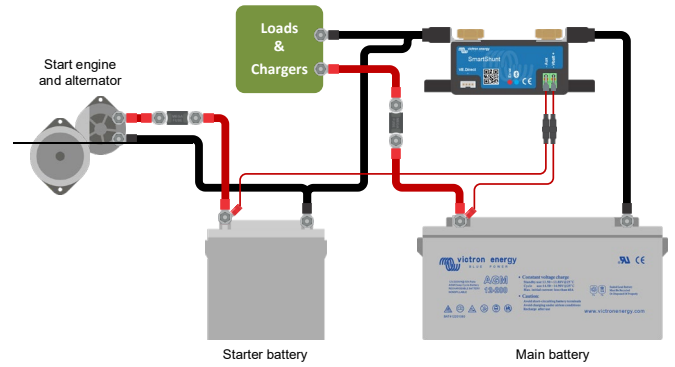

Measuring voltage of the starter battery

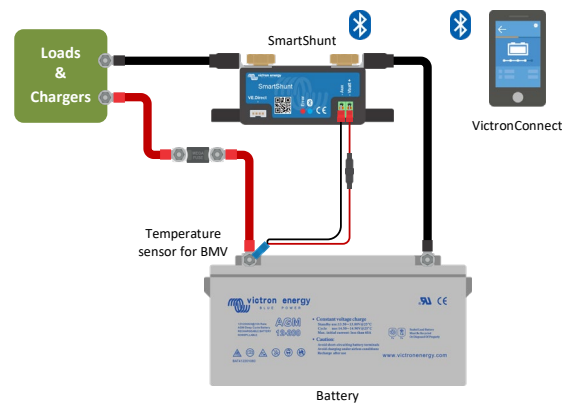

Measuring battery temperature

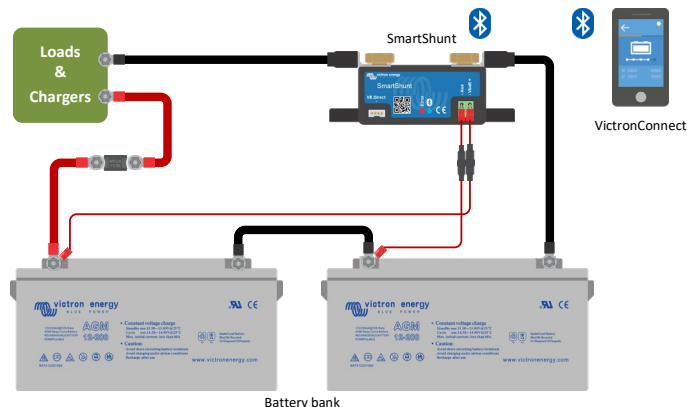

Measuring battery bank midpoint